

LINGARDS
EST. 1957

Homemade Cloth Face Masks

Did you know we offer
collection or postal delivery?

If you would like to order please email workroom@lingardfabrics.co.uk
and we can post to you or we will have collection available from our workroom
on **Tuesdays** between **10am** and **1pm** every week.

Homemade Cloth Face Masks

FAQs, Assembly Guide, and Patterns

Will homemade cloth masks protect against disease?

Hand washing remains a critical means of disease prevention for community members. When combined with social distancing and proper mask use, homemade cloth face masks may help slow the spread of COVID-19 in a community. Masks limit the spread of germs from the mask wearer to others by helping block large droplets from coughs and sneezes.

It is important for people who choose to use these masks to understand what type of protection they offer. Homemade cloth masks aren't as effective as clinical masks and offer limited protection for people in close contact with someone who is sick.

Whether using these masks or not, always practice social distancing, avoid touching your face, use good hygiene practices, and follow guidelines to safely use face masks.

Can I donate masks I make?

Before you sew masks to donate, find a recipient who agrees to take them. Hospitals, for example, may not accept these masks due to their limitations. Ask community organizations who serve vulnerable populations if they want to receive and distribute homemade cloth face masks. Finished masks should be packaged in a paper bag and held for three days before delivering them to users.

How do I clean a homemade cloth mask?

Homemade cloth masks should be properly cleaned before they are reused. To wash, launder masks in hot water (160°F) using soap or detergent that leaves no residue. Rinse well with fresh water and hang to dry. You may also disinfect masks by soaking them for 5 minutes in a solution of 2 tablespoons of bleach per quart of water or 1/3 cup of bleach per gallon of water.

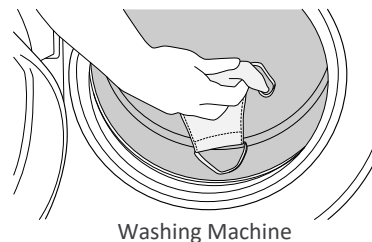

What type of fabric works best?

To be effective, a mask needs to filter out particles and still be easy enough to breathe through. If medical grade polypropylene is unavailable, 100% cotton and cotton blend fabrics are best.¹ The fabric in T-shirts and pillowcases are examples of this fabric.

1. Davies, Anna & Thompson, Katy-Anne & Giri, Karthika & Kafatos, George & Walker, James & Bennett, Allan (2013). Testing the Efficacy of Homemade Masks: Would They Protect in an Influenza Pandemic? Disaster medicine and public health preparedness. 7. 413-418. 10.1017/dmp.2013.43.

Assembly Guide

Preparation

Fabric

This mask has two layers—the inner layer touching the face and the outer layer. The two layers can be made of the same fabric or different fabrics. Use 100% cotton or a cotton blend for the best filtration and breathability.

It takes two pieces of fabric about 14.5 in. x 7.5 in. (36 cm. x 18 cm.) to make one adult mask (see Figure 1).

There are three sizes: Large, Medium, and Small. Patterns are available at the end of these instructions.

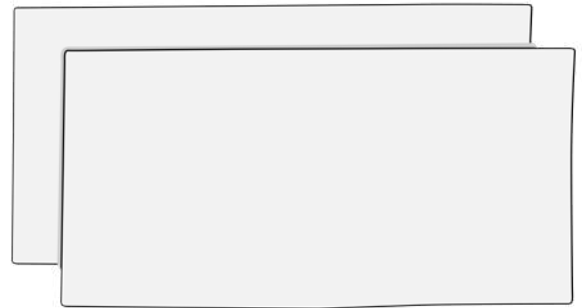

Figure 1

Ear Loop Material

Each mask needs two strips for ear loops. Ear loop material should be less than ½ inch (1.25 cm) wide. Some options are elastic, elastic cord, string, ribbon, bias tape, or even shoelaces.

If using elastic, each piece should be 12 inches (35.5 cm.) long. For other materials each piece should be 15 inches (38 cm) long (see Figure 2).

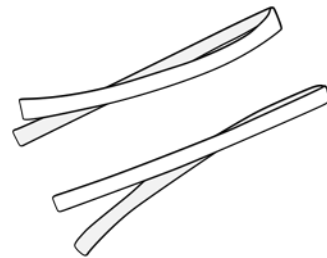

Figure 2

Sewing Equipment

- Sewing machine
- Scissors or rotary cutter
- Thread
- Straight pins
- Safety pins

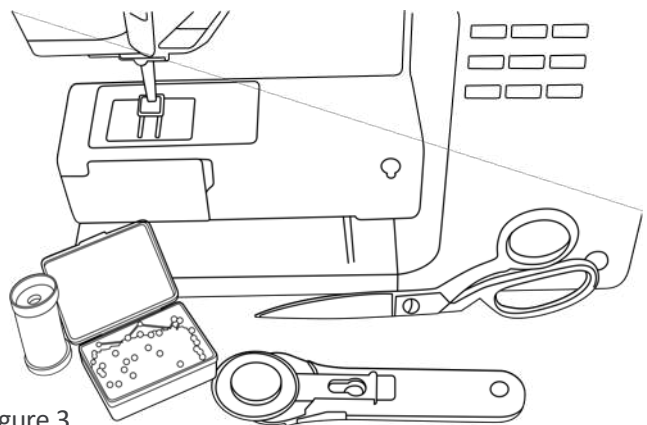

Figure 3

Work Area

Before you start sewing, ensure you are symptom free. Wash and sanitize your hands and your work area thoroughly with a disinfectant (it must indicate that it kills viruses) per the instructions on the label. Ensure there are no potential contaminants (e.g., pet hair, food, etc.) in the work area.

Assembly Guide

Sewing Instructions

Step 1—Cut out the two main mask pieces.

- Fold the fabric in half. On the folded edge of the fabric, place the pattern edge marked “place on fold” (see Figure 4).
- Pin the pattern on the fold of the fabric and cut it out.
- Repeat step 1 to cut the second piece.

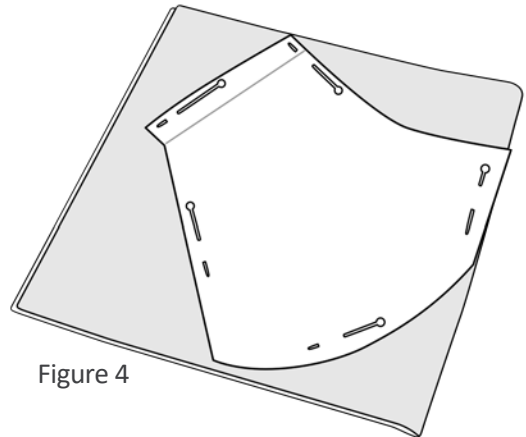

Figure 4

Step 2—Make the chin part of the mask.

- Open one of the cutout mask pieces. Fold it in half on the fold line, with the right sides inside.
- Sew along the chin seam, stitching 1/4 in (0.7 cm) from the edge (see Figure 5).
- If desired, press the seam to the side to help it lay flat.
- Fold and sew the second mask piece in the same way.

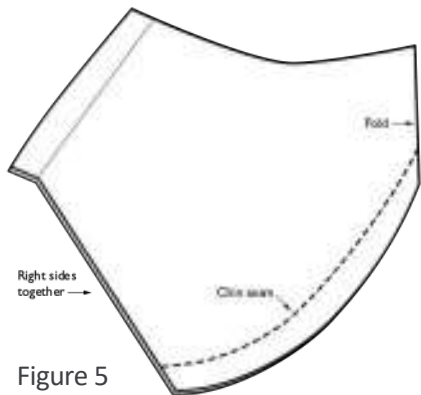

Figure 5

Step 3—Join the inner and outer layers together.

- Lay the two mask pieces on top of each other, with right sides of the fabric together (see Figure 6).
- Sew the two layers together across the top of the mask, using a 1/4 in (0.7 cm) seam.
- Sew the two layers together across the bottom of the mask.

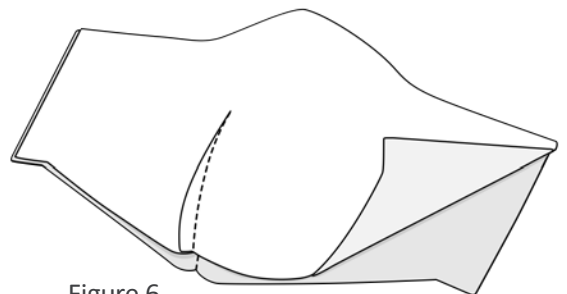

Figure 6

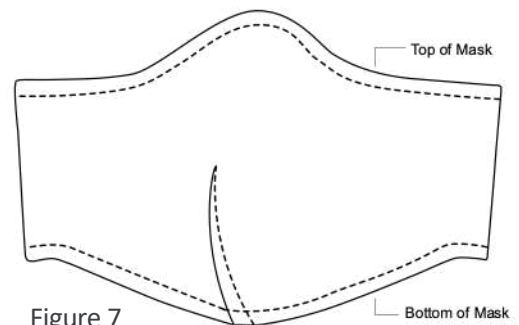

Figure 7

Step 4—Turn the mask right-side out.

- Press with an iron.

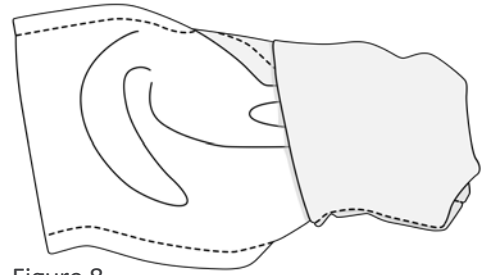

Figure 8

Step 5—Topstitch along the top and bottom edges.

- Keep your stitching close to the edges.
- Do not stitch across the sides of the mask.

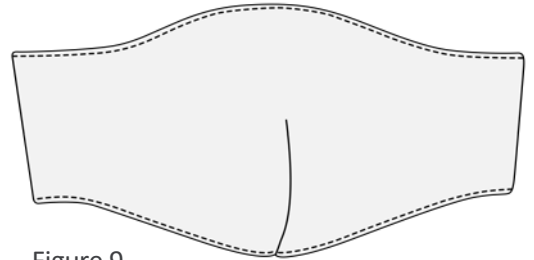

Figure 9

Step 6—Make the casing (a hollow channel) for the ear loop to go through.

On each side:

- Fold the raw side edges toward the inside of the mask about $\frac{1}{4}$ in (0.7 cm) (See Figure 10).
- Then fold over again, about $\frac{5}{8}$ in (1.5 cm).
- Pin in place and stitch as shown in Figure 11.

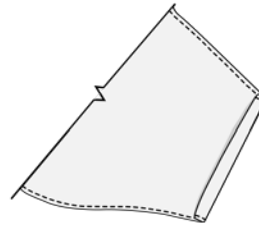

Figure 10

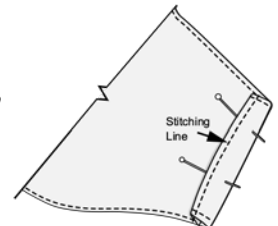

Figure 11

Step 7—Thread the ear loop through the casing along the sides of the mask.

- Use a large-eye plastic needle or attach the end of the elastic to a small safety pin. Push the elastic through the casing on both sides of the mask (see Figure 12).

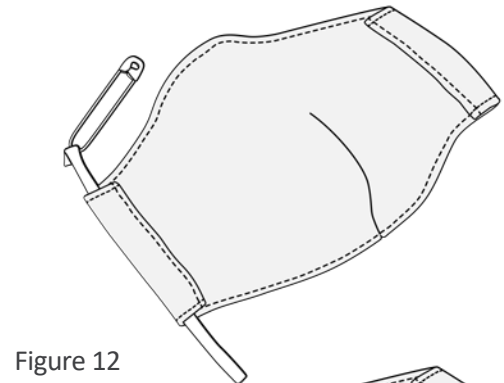

Figure 12

Step 8—Make loops the right size.

- Tie the loop ends loosely. The wearer can adjust the length by tying a knot (see Figure 13).

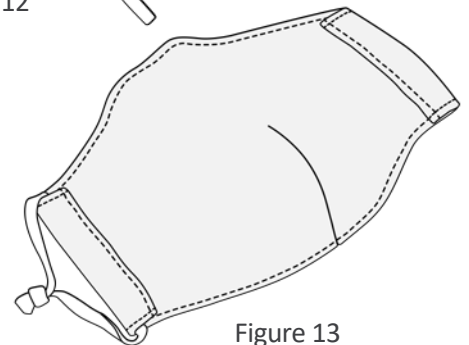
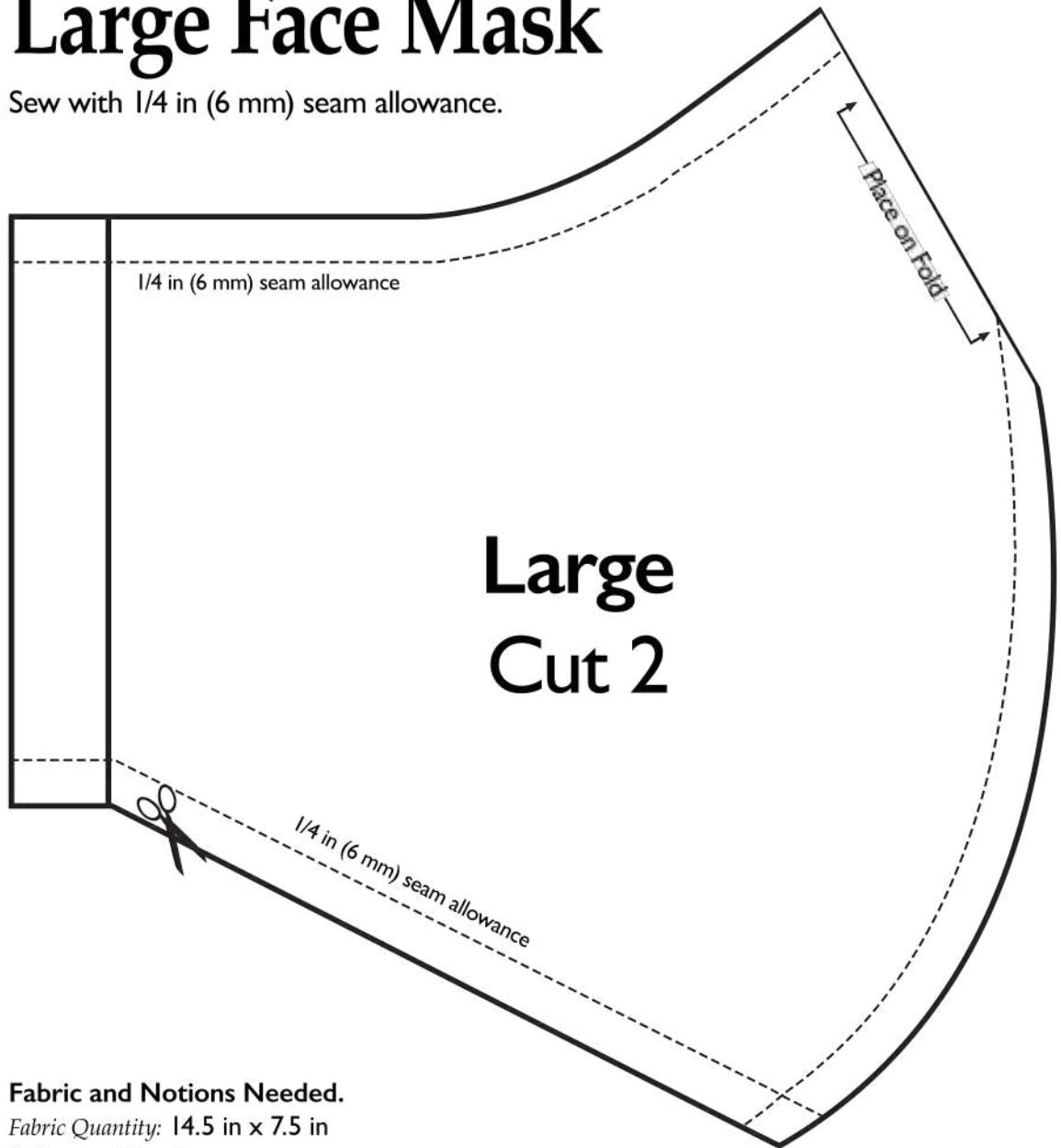

Figure 13

Large Face Mask

Sew with 1/4 in (6 mm) seam allowance.



Fabric and Notions Needed.

Fabric Quantity: 14.5 in x 7.5 in
(36 cm x 18 cm).

The best fabric is cotton T-shirts, pillow cases, or other cotton material.

Notions: Elastic, elastic cord, string, or ribbon [Loop material must be less than 1/2 in (1.25 cm) wide.]

When printed, this line should be 2 in (5 cm). Enlarge or reduce as necessary to ensure your pattern is accurate.

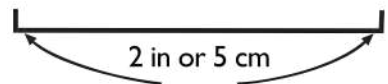

Medium Face Mask

Sew with 1/4 in (6 mm) seam allowance

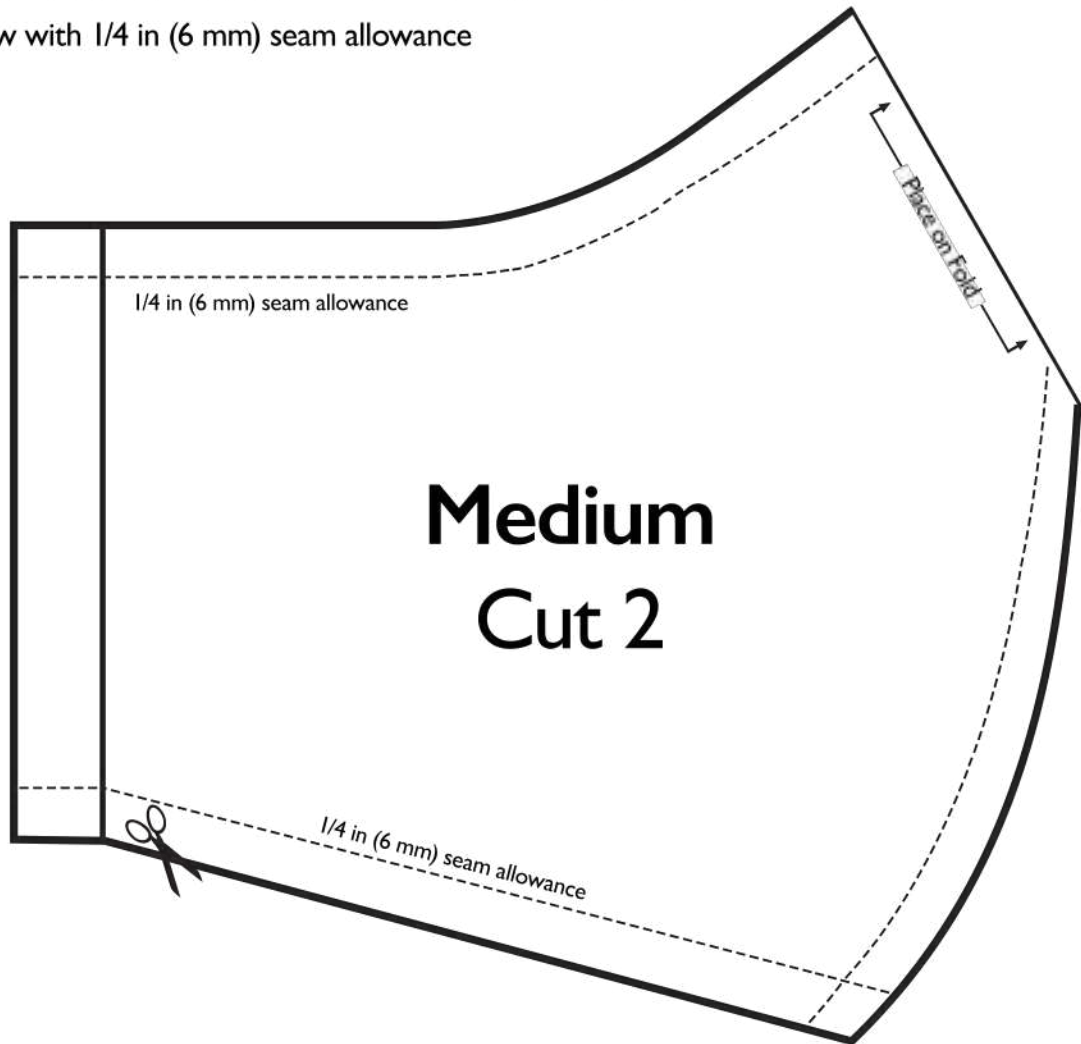

Fabric and Notions Needed.

Fabric Quantity: 14.5 in x 7.5 in
(36 cm x 18 cm).

The best fabric is cotton T-shirts, pillow cases, or other cotton material.

Notions: Elastic, elastic cord, string, or ribbon [Loop material must be less than 1/2 in (1.25 cm) wide.]

When printed, this line should be 2 in (5 cm). Enlarge or reduce as necessary to ensure your pattern is accurate.

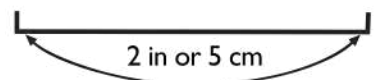

Small Face Mask

Sew with 1/4 in (6 mm) seam allowance

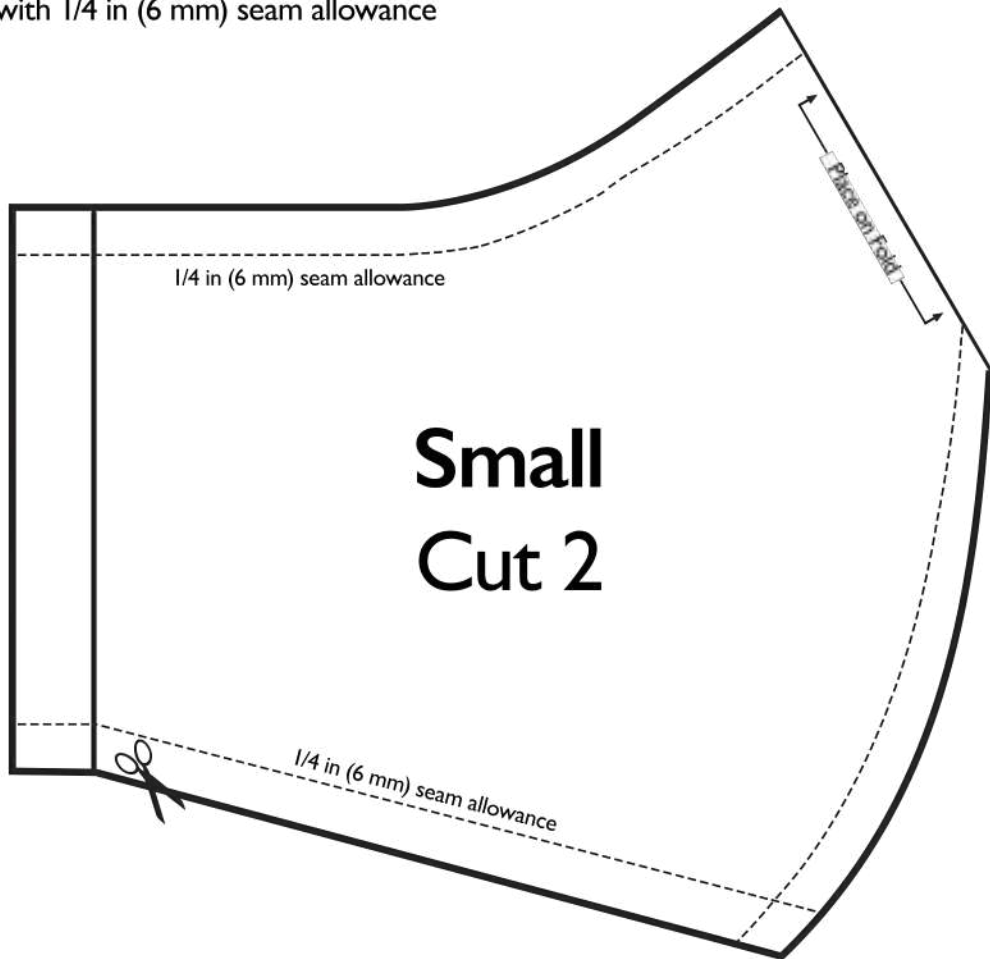

Fabric and Notions Needed.

Fabric Quantity: 14.5 in x 7.5 in
(36 cm x 18 cm).

The best fabric is cotton T-shirts, pillow cases, or other cotton material.

Notions: Elastic, elastic cord, string, or ribbon [Loop material must be less than 1/2 in (1.25 cm) wide.]

When printed, this line should be 2 in (5 cm). Enlarge or reduce as necessary to ensure your pattern is accurate.

